

marco empotrable
panel led
ficha técnica
datasheet

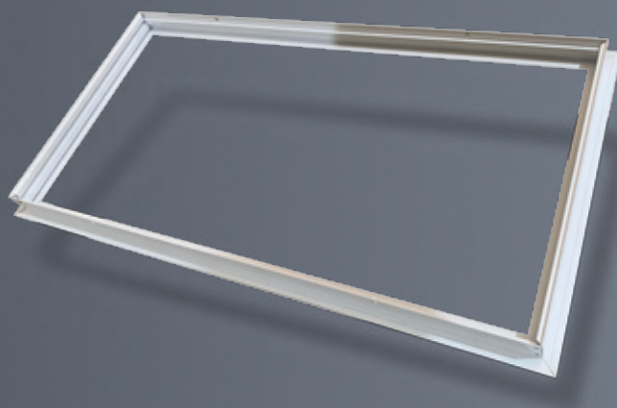

ref. 5551485

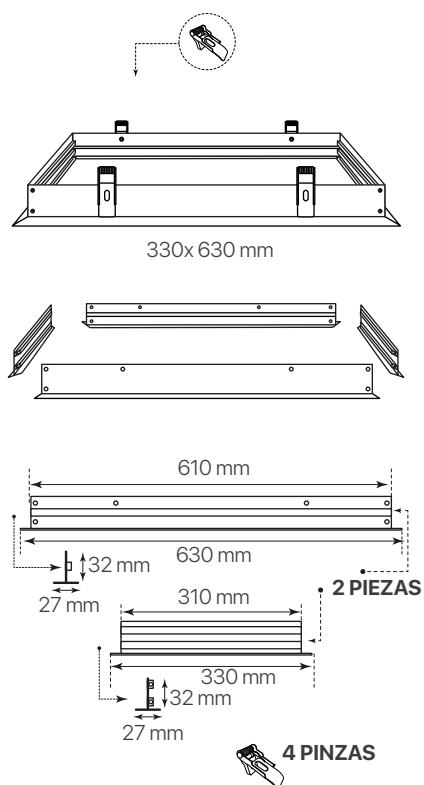

Nombre / Name	Marco empotrable para panel led
Referencia / Reference	5551485
Materiales / Materials	Aluminio / aluminum
Difusor / Diffuser	-
Potencia / Power	-
Temperatura de color / Color temperature	-
Flujo luminoso / Luminous flux	-
Dimable / Dimmable	-
Ángulo de apertura / Beam angle	-
Ángulo de inclinación / Inclination angle	-
IP	-
IK	-
F.P	-
UGR	-
IRC	-
Chip	-
Driver	-
Vida media (duración) / Average life	-
Clase energética / Energy class	-
Aislamiento eléctrico / Electrical isolation	-
Colores / Colors	Blanco / White
Medida exterior / Product size	330mm x 630mm x 32mm
Medidas de corte / Cutting measurements	310mm x 610mm
Tª (ambiente/trabajo) / Tª (enviroment/work)	-
Input	-
Output	-
Frecuencia / Frequency	-
Peso / Weight	-
Certificados / Certificates	-
Garantía / Warranty	-